



STEP13

Programmable Sequencer / Stepper

User Guide v1.5

**Designed By EasyPyro Ltd
Made in the UK**

Table of Contents

Front Panel.....	3
Technical Specification.....	4
Software Revision.....	4
Menu System.....	5
Useful Information.....	6
Error Codes.....	7
Battery Information.....	8
EQUAL INTERVAL MODE.....	9
DIFFERENT INTERVAL MODE.....	11
CLOCK MODE.....	13
STEP MODE.....	15
SWEEP MODE.....	16
Display Explanation.....	16
[Left > Right] & [Right > Left] Sweep.....	17
[Crossed] Sweep.....	22
[Centre > Out] Sweep.....	23

Front Panel

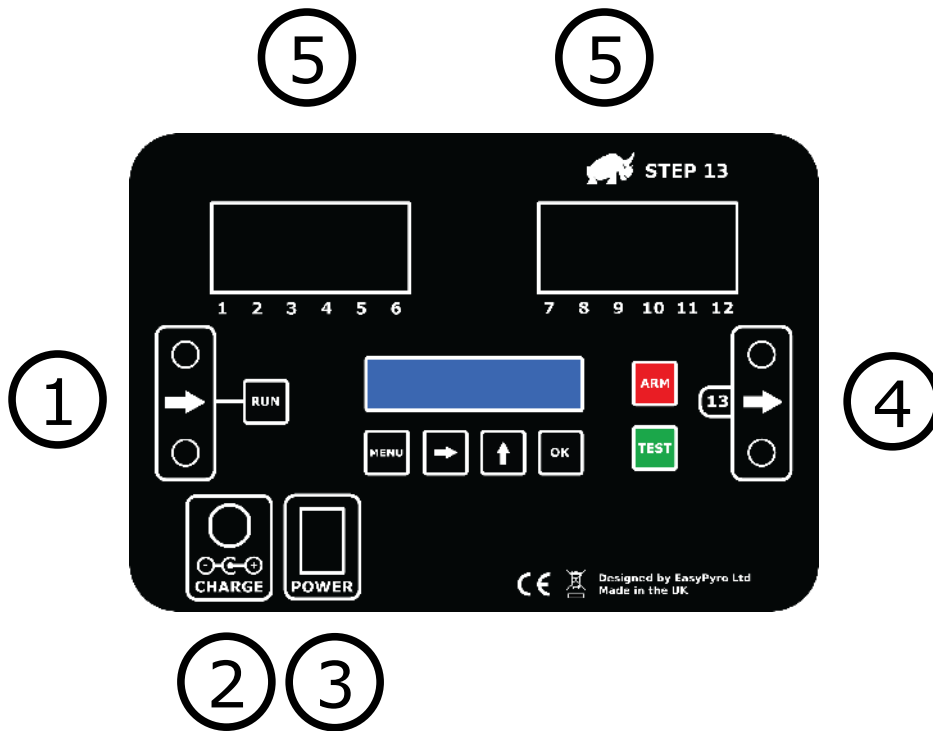

1	Trigger Input (PyroClip®)
2	Battery Charge Connector
3	Power Switch
4	Trigger Output / Cue 13 (PyroClip®)
5	Cue 1 - 12

Technical Specification

Input Trigger Resistance	18 Ω
Input Trigger Voltage	3 – 70 Volts
Output Voltage	12 Volts
Total Output Current	6 Amps
Minimum Interval Time	10 ms
Maximum Interval Time	9m59.99s
Maximum Clock Time	9m59.99s
Battery Charge Time	1 hours
Battery Charger Plugs	USA / UK / EURO
Battery Type	YUASA NP0.8-12
Standby Time	20+ hours
Maximum e-match in series	8+ (assuming no cue overlap)
Maximum e-match in parallel	6+ (assuming no cue overlap)
CE Approved	Yes
Weight	1.4 Kg / 3 lbs.





Software Revision

Software Revision	Changes
v0.1 – v1.0	BETA TEST
v1.2	OFFICIAL RELEASE March 2012
v1.3	Feature Added <ol style="list-style-type: none"> 1. Unit left on warning 2. Continuously variable pulse times 3. Start / Stop timed sequences 4. Simplified menu structure
v1.4	Bug Fix <ol style="list-style-type: none"> 1. Fixed long term timing drift Feature Added <ol style="list-style-type: none"> 1. Trigger Input indication to check if unit is being trigger correctly 2. Factory Reset option
v1.5	Feature Added <ol style="list-style-type: none"> 1. Split Equal Interval mode into groups of cues 1x12, 2x6, 3x4 etc

Menu System

MENU ITEM	DESCRIPTION
1] Equal	Set an equal time interval between cues
All	Fire all the cues on 1 st Trigger Pulse
1x12	Fire Cue 1 – 12 on 1 st Trigger Pulse Fire Cue 13 / Trigger Out on all other Trigger Pulses
2x6	Fire Cue 1 – 6 on 1 st Trigger Pulse Fire Cue 7 – 12 on 2 nd Trigger Pulse Fire Cue 13 / Trigger Out on all other Trigger Pulses
3x4	Fire Cue 1 – 4 on 1 st Trigger Pulse Fire Cue 5 – 8 on 2 nd Trigger Pulse Fire Cue 9 – 12 on 3 rd Trigger Pulse Fire Cue 13 / Trigger Out on all other Trigger Pulses
4x3	...
6x2	...
2] Different	Set different time intervals between cues
2.1] Setup	Setup a series of intervals
2.2] Load Show	Load a stored series of intervals
2.3] Clear Show	Clear a stored series of intervals
3] Clock	Set the time a cue will fire according to a clock
3.1] Setup	Setup a series of times
3.2] Load Show	Load a stored series of times
3.3] Clear Show	Clear a stored series of times
4] Step	Step to the next cue on each input pulse.
5] Sweep	Timed [Left > Right], [Right > Left] sweeps across multiple firing sites.
6] Setup	Device configuration options
6.1] Pulse	Set the duration of the firing pulse (0.01s – 9.99s)
6.2] Beep	Enable or disable all beeps (ON, OFF)
6.3] LED	Enable or disable the external ARM indicator (ON, OFF)
6.4] Language	Set the menu language (EN, ES, IT, DE, FR)
6.5] Reset	Factory Reset.

Useful Information

- The lid can be closed and locked over e-match wires.
- Press  at any time to simulate a sequence on the screen. This will not fire cues.
- Hold  and press & release  at to provide an emergency Trigger Input and start the sequence. This will fire cues.
- Press  after you have set up the device. The device will beep and flash every 1 second. It is now waiting for a Trigger Input pulse to fire cues.
- Hold  for 1 second to clear what you have entered.
- You can press any button to disarm the system.
- You can disable the beep and flash in the menu.
- The display backlight will turn off after 30 seconds. Press any button to turn it on again. Press the button again to execute the function.
- You can save up to 10 sequences in each mode, to be recalled at a later date.
- Simply push down the PyroClips (Trigger Input and Trigger Output), insert the wire and release. There is no need to wrap or twist the wire.
- To prolong the life of the Terminals (Cues 1 – 12) when removing wires, depress the springs and remove each e-match wire pair-by-pair. Do not simply “grab and pull” wires.
- If the device is not used regularly, charge it once every 3 months to keep the battery in good condition.
- The device will beep and flash every 1 minute after 5 minutes of inactivity to warn you it is ON. This can be disabled.
- The sequences can be paused / started by successive Trigger Input Pulses.
- The Trigger Output / Cue 13 behaves differently according to which mode the device is in.

Mode	Trigger Output / Cue 13 Behaviour
Equal [All]	Normal Cue.
Equal [1x12],[2x6],[3x4] etc	Device will pulse Trigger Output on each Trigger Input pulse received after all Cues have been fired on device.
Different, Clock Mode	Normal Cue.
Step Mode	Device will pulse Trigger Output on each Trigger Input pulse received after all Cues have been fired on device.
Sweep Mode	Device will immediately pulse Trigger Output on each Trigger Input pulse received.

Error Codes

The device will run a SELF TEST on power up.

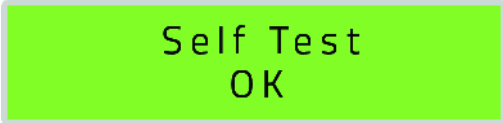

If you see an error code, please do not use the device and contact us immediately.

Error Code	Description
00	Any Cue MOSFET stuck ON.
01	Cue 1 MOSFET stuck OFF.
02	Cue 2 MOSFET stuck OFF.
03	Cue 3 MOSFET stuck OFF.
04	Cue 4 MOSFET stuck OFF.
05	Cue 5 MOSFET stuck OFF.
06	Cue 6 MOSFET stuck OFF.
07	Cue 7 MOSFET stuck OFF.
08	Cue 8 MOSFET stuck OFF.
09	Cue 9 MOSFET stuck OFF.
10	Cue 10 MOSFET stuck OFF.
11	Cue 11 MOSFET stuck OFF.
12	Cue 12 MOSFET stuck OFF.
13	Cue 13 MOSFET stuck OFF.
14	ARM MOSFET stuck ON.
15	RUN Button stuck ON.
16	MENU Button stuck ON.
17	LEFT Button stuck ON.
18	UP Button stuck ON.
19	OK Button stuck ON.
20	ARM Button stuck ON.
21	TEST Button stuck ON.

Battery Information

RhinoFire v1.0
12.5v 100%

Battery Voltage	Percentage %
> 12.5 volts	100%
< 9 volts	0%

Note: Charge the battery every 3 months to keep it in good condition.

EQUAL INTERVAL MODE

Equal Interval Mode is used to quickly set the same interval between all cues.





Cues can be fired together or in groups.



Multiple devices can be connected together and cues fired in groups along the chain.

Option	Function
All	Fire Cues [1–13] with an Equal Interval.
1x12	Fire Cues [1–12] with an Equal Interval.
2x6	Fire Cues [1–6] and [7–12] with an Equal Interval.
3x4	Fire Cues [1–4], [5–8] and [9–12] with an Equal Interval.
4x3	Fire Cues [1–3], [4–6], [7–9], [10–12] with an Equal Interval.
6x2	Fire Cues [1-2], [3-4], [5-6], [7-8], [9-10], [11-12] with an Equal Interval.

Example

<p>Equal All 0m05.00s</p>	Trigger 1	Cue 1–13 will fire with 5s interval
	Trigger 2	Nothing
	Trigger 3	Nothing
	Trigger 4	Nothing
<p>Equal 1x12 0m01.75s</p>	Trigger 1	Cue 1–12 will fire with 1.75s interval
	Trigger 2	Cue 13 / Trigger Out will fire
	Trigger 3	Cue 13 / Trigger Out will fire
	Trigger 4	Cue 13 / Trigger Out will fire
<p>Equal 2x6 0m01.75s</p>	Trigger 1	Cue 1–6 will fire with 1.75s interval
	Trigger 2	Cue 7–12 will fire with 1.75s interval
	Trigger 3	Cue 13 / Trigger Out will fire
	Trigger 4	Cue 13 / Trigger Out will fire
<p>Equal 3x4 0m05.00s</p>	Trigger 1	Cue 1–4 will fire with 5s interval
	Trigger 2	Cue 5–8 will fire with 5s interval
	Trigger 3	Cue 9–12 will fire with 5s interval
	Trigger 4	Cue 13 / Trigger Out will fire

1. Press  and use  to navigate to Equal Interval Mode.
2. Press  to enter the mode.
3. Use  and  to set the desired time delay and operating mode.

After you have setup or loaded a sequence, you can press  to simulate the sequence, or  to ARM the system before use.

DIFFERENT INTERVAL MODE





Different Interval Mode is used to set different time intervals between cues.

Different Interval Mode is a "relative time" mode. This means each time delay is relative to the previous time delay.







Example

Different 01-02 0m00.50s	Cue 2 will fire 0.50s after Cue 1.
Different 02-03 0m02.35s	Cue 3 will fire 2.35s after Cue 2.
Different 03-04 0m06.00s	Cue 4 will fire 6.00s after Cue 3.
Different 04-05 1m18.40s	Cue 5 will fire 1m18.40s after Cue 4.

You can save and recall up to 10 sets of time delays in Different Interval Mode.



1. Press  and use  to navigate to Different Interval Mode.
2. Press  to enter the mode.
3. Use  and  to select **SETUP**, **LOAD** or **CLEAR** as desired.

For **SETUP**,



1. Use  and  to set the desired time delay between cues.
2. Press  to advance to the next delay. You can review or change a previously entered time delay by pressing  several times to loop back to the delay you want.
3. The final option is **Save Show?**. The default is **No**. You can press  to loop back to the start of the time delays OR you can use  and  to select which show number (1 – 10) you want to save the show as. An **asterisk (*)** next to the show number indicates a show is already stored in that memory location. You can overwrite an existing show if you want.

Note: It is not necessary to save a show to fire or reuse a show. The current show will stay in memory even if the unit is switched off or the mode is changed. It is only necessary to save a show if you wish to enter a new show in that mode and recall the saved show at a later date.

For **LOAD**,

1. Use  and  to recall the desired show from memory. The recalled show can now be fired, reviewed or edited in the usual way. An **asterisk (*)** next to the show number indicates a show is stored in that memory location.

For **CLEAR**,

1. Use  and  to delete the selected show from memory. An **asterisk (*)** next to the show number indicates a show is stored in that memory location.

After you have setup or loaded a sequence, you can press  to simulate the sequence, or

 to ARM the system before use.

CLOCK MODE

Clock Mode is used to set different time intervals between cues.





Clock Mode is an "absolute time" mode. This means the time a cue fires is set to a clock. The clock will start running as soon as a Trigger Input pulse is received. All other Trigger Inputs are ignored.

Example



Clock 01 0m00.50s	Cue 1 will fire 0.50s after the 1st Trigger Input.
Clock 02 0m02.35s	Cue 2 will fire 2.35s after the 1 st Trigger Input.
Clock 03 0m06.00s	Cue 3 will fire 6.00s after the 1 st Trigger Input.
Clock 04 1m18.40s	Cue 4 will fire 1m18.40s after the 1 st Trigger Input.
Clock 13 2m35.00s	Cue 13 will fire 2m35.00s after the 1 st Trigger Input.





Note: It does not matter what order the Cues fire. For example, you could fire Cue 12 at 0.5s after Trigger Input and Cues 1,2,3 and 6 25s after Trigger Input. Any Cue set to 0s will fire immediately on Trigger Input.

You can save and recall up to 10 sets of time delays in Clock Mode.

1. Press  and use  to navigate to Clock Mode.
2. Press  to enter the mode.
3. Use  and  to select **SETUP**, **LOAD** or **CLEAR** as desired.



For **SETUP**,

1. Use  and  to set the desired time a cue will fire.



2. Press  to advance to the next cue. You can review or change a previously entered cue time by pressing  several times to loop back to the cue time you want.
3. The final option is **Save Show?**. The default is **No**. You can press  to loop back to the start of the cue times OR you can use  and  to select which show number (1 – 10) you want to save show as. An **asterisk (*)** next to the show number indicates a show is already stored in that memory location. You can overwrite an existing show if you want.



Note: It is NOT necessary to save a show to fire or reuse a show. The current show will stay in memory even if the unit is switched off or the mode is changed. It is only necessary to save a show if you wish to enter a new show in that mode and recall the saved show at a later date.

For **LOAD**,

1. Use  and  to recall the desired show from memory. The recalled show can now be fired, reviewed or edited in the usual way. An **asterisk (*)** next to the show number indicates a show is stored in that memory location.

For **CLEAR**,

1. Use  and  to delete the selected show from memory. An **asterisk (*)** next to the show number indicates a show is stored in that memory location.

After you have setup or loaded a sequence, you can press  to simulate the sequence, or  to ARM the system before use.

STEP MODE

Step Mode is used to step to the next cue on each successive Trigger Input pulse. After the final Cue is fired on a device, the Trigger Output will continue to pulse when a Trigger Input pulse is detected. Many devices can be connected together by connecting the Trigger Output from a device to the Trigger Input of the next device.

The illustration below shows 5 devices connected to give 60 cues, all fired from 1 cue on an existing firing system.

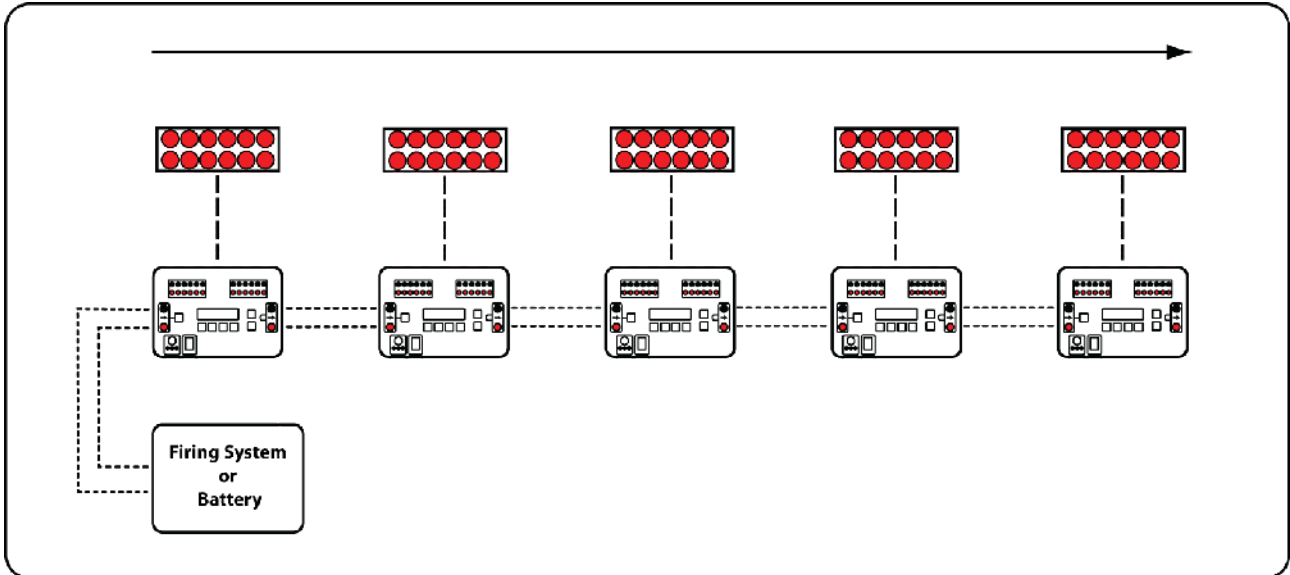

Illustration 1: Step Mode

Note: It does NOT matter which way around the Trigger Input and Trigger Output terminals are connected. You do NOT need to match red to red and black to black.

SWEEP MODE

Sweep Mode allows "right to left", "left to right", "centre out" and "crossed" sweep sequences to be easily created using multiple devices.

Each time a Trigger Input pulse is received, the devices will fire the next free cue in order with a time delay between each firing site.

You do not need to use a separate device for each firing site. Each device can be set up with multiple sites. This reduces the number of devices and amount of wire needed to fire wide firing fronts.

Each device can have a number of firing sites allocated to it.

Number of firing sites per device	Cues per firing site	Split of Cues on device
1	12	[1-12]
2	6	[1-6] & [7-12]
3	4	[1-4] & [5-8] & [9-12]
4	3	[1-3] & [4-6] & [7-9] & [10-12]
6	2	[1-2] & [3-4] & [5-6] & [7-8] & [9-10] & [11-12]

Note: On each successive Trigger Input pulse, the direction of fire will reverse.

Display Explanation

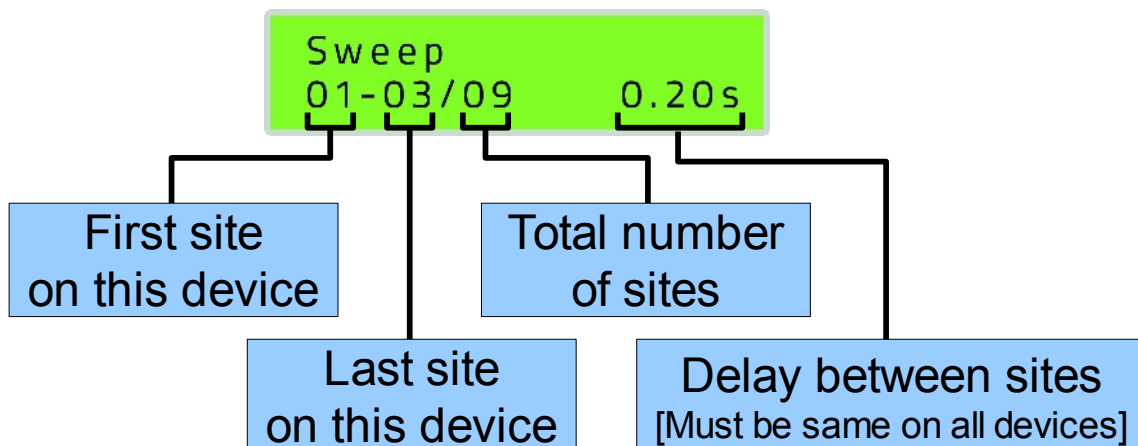

[Left > Right] & [Right > Left] Sweep

Example 1

The example below shows 9 sites of 4 cues each for a total of 36 cues, with 0.2s delay between each site.

Device	Screen	Description
A	Sweep 01-03/09 0.20s	Device A is set up with sites 1-3 of 9 and interval 0.2s.
B	Sweep 04-06/09 0.20s	Device B is set up with sites 4-6 of 9 and interval 0.2s.
C	Sweep 07-09/09 0.20s	Device C is set up with sites 7-9 of 9 and interval 0.2s.

Trigger Input Number ...	Behaviour
1st	Sweep Left – Right Cue 1 on sites 1 – 9 fire with a 0.2s delay between each site, going from Site 1 to Site 9.
2nd	Sweep Right – Left Cue 2 on sites 1 – 9 fire with a 0.2s delay between each site, going from Site 9 to Site 1.
3rd	Sweep Left – Right Cue 3 on sites 1 – 9 fire with a 0.2s delay between each site, going from Site 1 to Site 9.
4th	Sweep Right – Left Cue 4 on sites 1 – 9 fire with a 0.2s delay between each site, going from Site 9 to Site 1.
5th ...	There are no more cues to fire. All devices will have automatically disarmed.

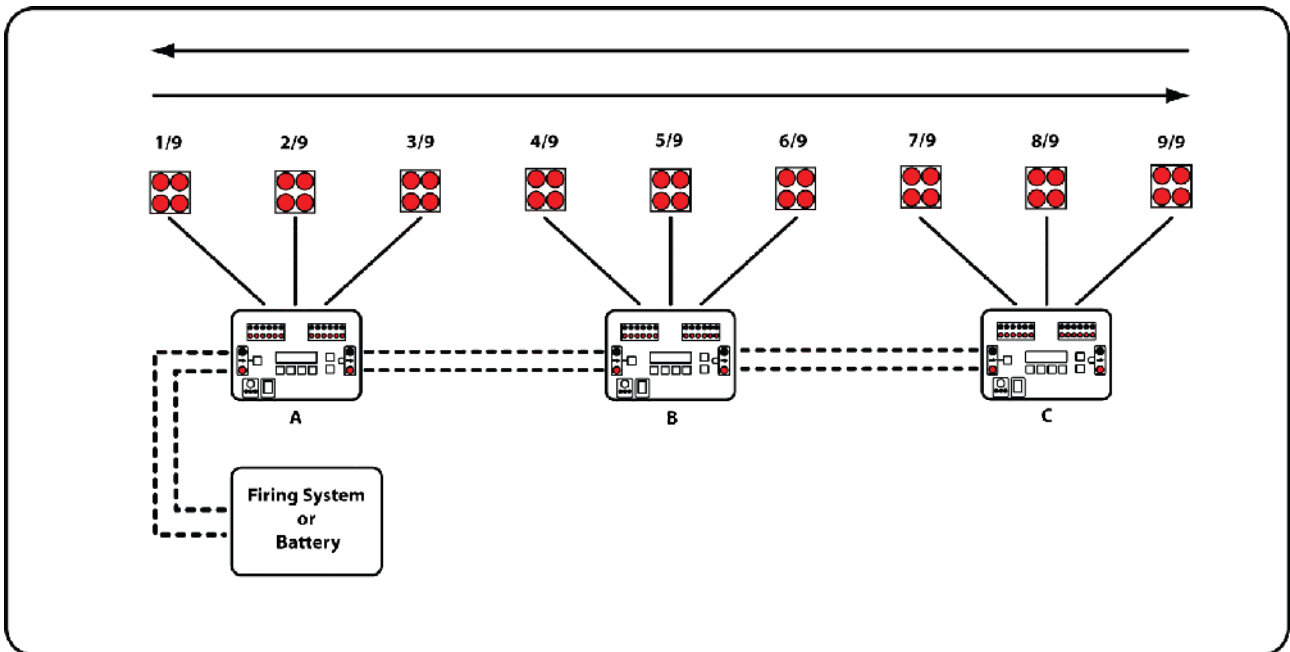

Illustration 2: Sweep Mode [Left > Right] & [Right > Left]

Note: Each time delay MUST be the same. For example, to achieve a sweep with 0.1s between each firing site, the time on EACH device MUST be set to 0.1s.

Example 2

The example below shows 8 sites of 6 cues each for a total of 48 cues, with 0.15s delay between each site.

Device	Screen	Description
A	Sweep 01-02/08 0.15s	Device A is set up with sites 1-2 of 8 and interval 0.15s.
B	Sweep 03-04/08 0.15s	Device B is set up with sites 3-4 of 8 and interval 0.15s.
C	Sweep 05-06/08 0.15s	Device C is set up with sites 5-6 of 8 and interval 0.15s.
D	Sweep 07-08/08 0.15s	Device D is set up with sites 7-8 of 8 and interval 0.15s.

Trigger Input Number ...	Behaviour
1st	Sweep Left – Right Cue 1 on sites 1 – 8 fire with a 0.15s delay between each site, going from Site 1 to Site 8.
2nd	Sweep Right – Left Cue 2 on sites 1 – 8 fire with a 0.15s delay between each site, going from Site 8 to Site 1.
3rd	Sweep Left – Right Cue 3 on sites 1 – 8 fire with a 0.15s delay between each site, going from Site 1 to Site 8.
4th	Sweep Right – Left Cue 4 on sites 1 – 8 fire with a 0.15s delay between each site, going from Site 8 to Site 1.
5th	Sweep Left – Right Cue 5 on sites 1 – 8 fire with a 0.15s delay between each site, going from Site 1 to Site 8.
6 th	Sweep Right – Left Cue 6 on sites 1 – 8 fire with a 0.15s delay between each site, going from Site 8 to Site 1.
7 th ...	There are no more cues to fire. All devices will have automatically disarmed.

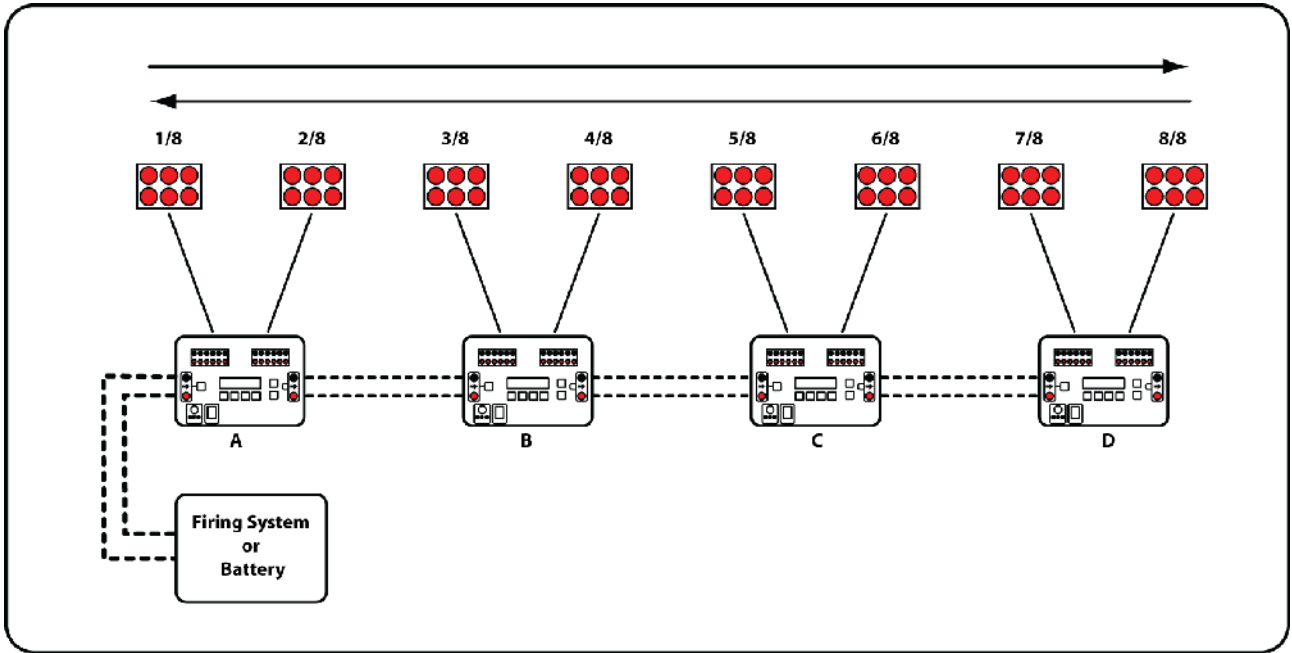

Illustration 3: Sweep Mode [Left > Right] & [Right > Left]

[Crossed] Sweep

The device does not need to wait until 1 sweep is finished before starting the next. 2 quick Trigger Input pulses will cause the "Right to Left" and "Left to Right" sweeps to start at approximately the same time. This gives the impression of the effects coming in from each side and crossing in the middle.

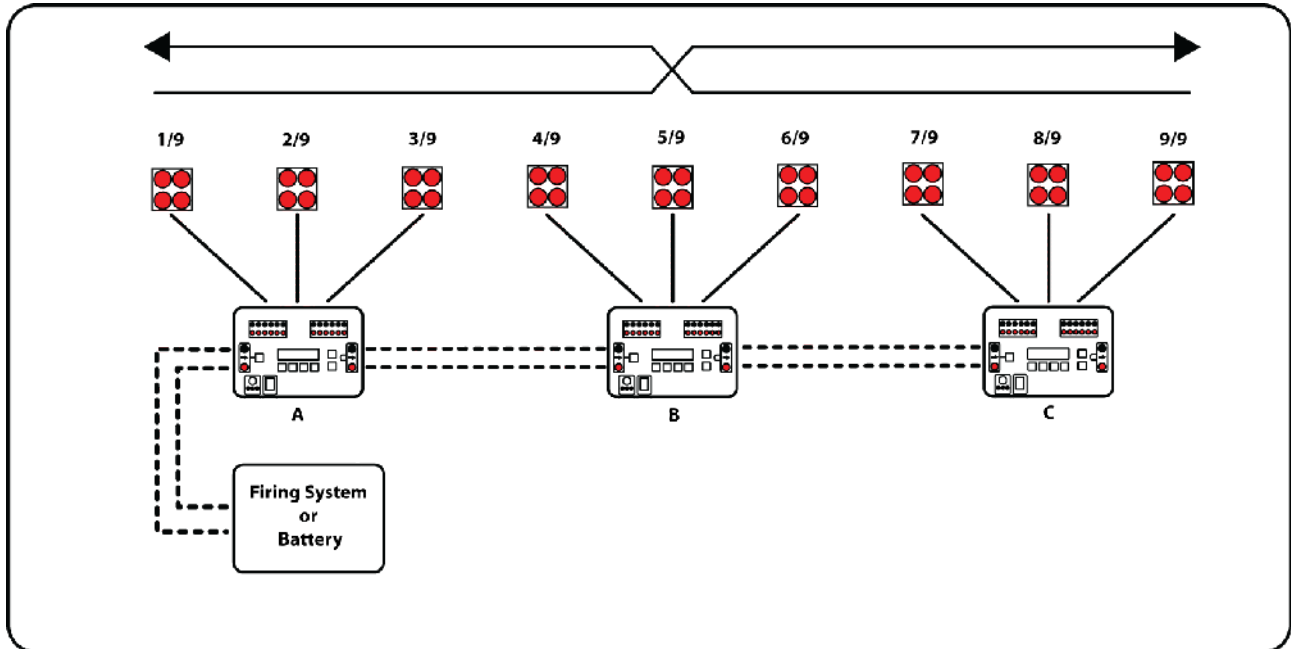

Illustration 4: Sweep Mode [Crossed]



[Centre > Out] Sweep

A centre out sweep can be created by using an even number of devices and mirroring them.

Devices marked A share the same configuration and devices mark B share the same configuration.

The example below shows 12 sites of 4 cues each for a total of 48 cues.

Example 1

Device	Screen	Description
A		Device's marked A are set up with sites 1-3 of 6 and time delay 0.1s.
B		Device's marked B are set up with sites 4-6 of 6 and time delay 0.1s.

Trigger Input Number ...	Behaviour
1st	Sweep Centre – Out Cue 1 on sites 1 – 6 fire with a 0.1s delay between each site, going from Site 1 to Site 6 on both sides.
2nd	Sweep Right – Left Cue 2 on sites 1 – 6 fire with a 0.1s delay between each site, going from Site 6 to Site 1 on both sides.
3rd	Sweep Left – Right Cue 3 on sites 1 – 6 fire with a 0.1s delay between each site, going from Site 1 to Site 6.
4th	Sweep Right – Left Cue 4 on sites 1 – 6 fire with a 0.1s delay between each site, going from Site 6 to Site 1.
5th ...	There are no more cues to fire. All devices will have automatically disarmed.

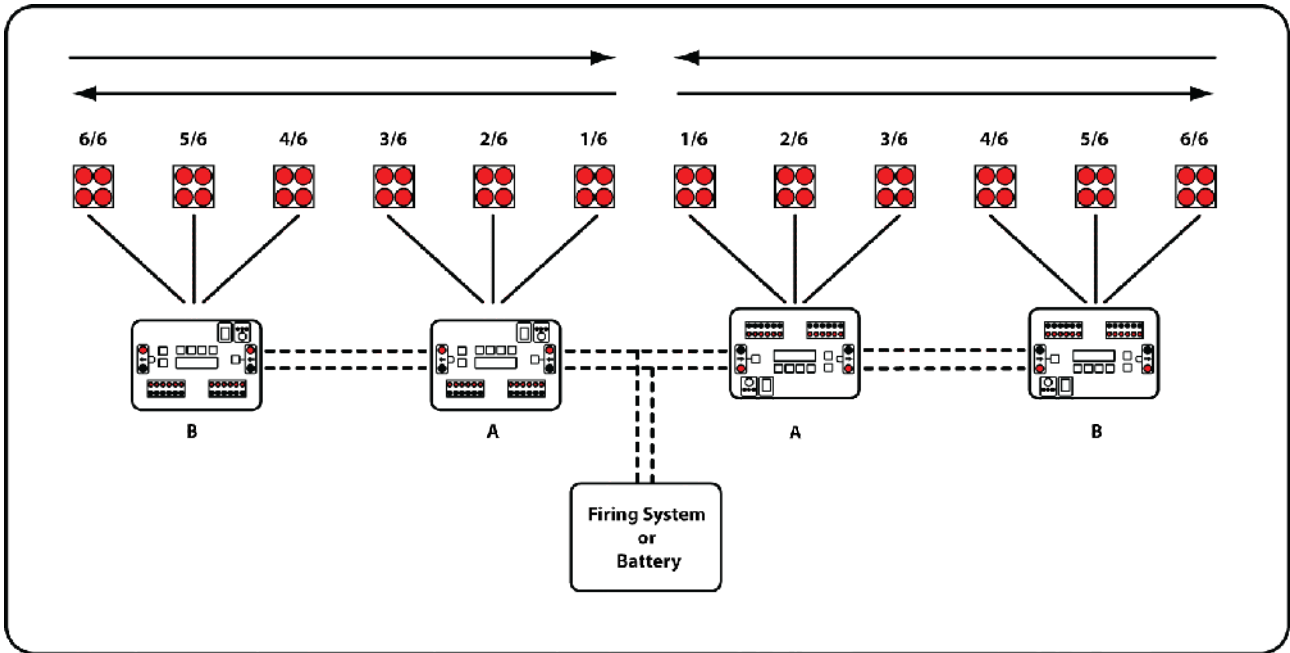

Illustration 5: Sweep Mode [Centre > Out]

Note: The left 2 devices are shown inverted (upside down) to aid the layout of the diagram.